

**Professional high-speed optical transceiver**

**OPN-SGD48-120LC2 / OPN-SGD48-120LC2I**

**1.25Gbps / 120km / 100GHz DWDM Digital Diagnostic LC SFP SINGLE-MODE TRANSCEIVER**

**PRODUCT FEATURES**

- Hot-Pluggable SFP Footprint LC Optical Transceiver
- Small Form-Factor Pluggable (SFP) MSA compatible
  - Compliant with IEEE 802.3z Gigabit Ethernet
- Compliant with Fibre Channel FC-PI 100-SM-LL-V
  - Distance up to 120km
- Temperature-stabilized DWDM DML Transmitter
  - 32 dB Power Budget at Least
  - 100 GHz ITU Grid, C Band
  - SFF-8472 Digital Diagnostic Function
  - AC/AC Coupling according to MSA
    - Single +3.3 V Power Supply
    - RoHS Compliant
  - 0 to 70°C Operation: OPN-SGD48-120LC2
  - -50 to 85°C Operation : OPN-SGD48-120LC2I
- Class 1 Laser International Safety Standard IEC-60825Compliant

**APPLICATIONS**

- Gigabit Ethernet Switches and Routers
- Fibre Channel Switch Infrastructure
  - XDSL Applications
  - Metro Edge Switching
- CPRI option 2: 1228.8 Mbit/s
- CPRI option 1: 614.4 Mbit/s
  - OBSAI 768 MBaud

**PRODUCT DESCRIPTION**

The OPN-SGD48-120LC2 series single mode transceiver is a small form factor pluggable module for bi-directional serial optical data communications such as Gigabit Ethernet 1000BASE-ZX and Fibre Channel FC-PI 100-SM-LL-V. It is with the SFP 20-pin connector to allow hot plug capability. Digital diagnostic functions are available via anI<sup>2</sup>C. This module is designed for single mode fiber and operates at a nominal wavelength of 100GHz ITU Grid, CBand DWDM wavelength. A guaranteed minimum optical link budget of 32 dB is offered. The transmitter section uses temperature-stabilized DWDM directly modulated laser (DML) and is class 1 laser compliant according to International Safety Standard IEC-60825. The receiver section uses an integrated InGaAs Avalanche photodetector preamplifier mounted in an optical header and a limiting post-amplifier IC.

**ORDER INFORMATION**

P/No.	Bit Rate (Gb/s)	1000BASE	Distance (km)	Spacing (GHz)	Wavelength (nm)	Package	Temp (°C)	RoHS Compliant
OPN-SGD48-120LC2	1.25		120	100	DWDM*	LC SFP with DMI	0 to 70	Yes
OPN-SGD48-120LC2I	1.25		120	100	DWDM*	LC SFP with DMI	-50 to 85	Yes

\*: XX: 100GHz ITU Grid wavelength (Please see below)

Channel #	Product code	Frequency (THz)	Center Wavelength (nm)	Label
20	OPN-SGD48-120LC2	192.0	1561.42	D20
21	OPN-SGD21-120LC2	192.1	1560.61	D21
22	OPN-SGD22-120LC2	192.2	1559.79	D22
23	OPN-SGD23-120LC2	192.3	1558.98	D23
24	OPN-SGD24-120LC2	192.4	1558.17	D24
25	OPN-SGD25-120LC2	192.5	1557.36	D25
26	OPN-SGD26-120LC2	192.6	1556.55	D26
27	OPN-SGD27-120LC2	192.7	1555.75	D27

### Professional high-speed optical transceiver

28	OPN-SGD28-120LC2	192.8	1554.94	D28
29	OPN-SGD29-120LC2	192.9	1554.13	D29
30	OPN-SGD30-120LC2	193.0	1553.33	D30
31	OPN-SGD31-120LC2	193.1	1552.52	D31
32	OPN-SGD32-120LC2	193.2	1551.72	D32
33	OPN-SGD33-120LC2	193.3	1550.92	D33
34	OPN-SGD34-120LC2	193.4	1550.12	D34
35	OPN-SGD35-120LC2	193.5	1549.32	D35
36	OPN-SGD36-120LC2	193.6	1548.51	D36
37	OPN-SGD37-120LC2	193.7	1547.72	D37
38	OPN-SGD38-120LC2	193.8	1546.92	D38
39	OPN-SGD39-120LC2	193.9	1546.12	D39
40	OPN-SGD40-120LC2	194.0	1545.32	D40
41	OPN-SGD41-120LC2	194.1	1544.53	D41
42	OPN-SGD42-120LC2	194.2	1543.73	D42
43	OPN-SGD43-120LC2	194.3	1542.94	D43
44	OPN-SGD44-120LC2	194.4	1542.14	D44
45	OPN-SGD45-120LC2	194.5	1541.35	D45
46	OPN-SGD46-120LC2	194.6	1540.56	D46
47	OPN-SGD47-120LC2	194.7	1539.77	D47
48	OPN-SGD48-120LC2	194.8	1538.98	D48
49	OPN-SGD49-120LC2	194.9	1538.19	D49
50	OPN-SGD50-120LC2	195.0	1537.40	D50
51	OPN-SGD51-120LC2	195.1	1536.61	D51
52	OPN-SGD52-120LC2	195.2	1535.82	D52
53	OPN-SGD53-120LC2	195.3	1535.04	D53
54	OPN-SGD54-120LC2	195.4	1534.25	D54
55	OPN-SGD55-120LC2	195.5	1533.47	D55
56	OPN-SGD56-120LC2	195.6	1532.68	D56
57	OPN-SGD57-120LC2	195.7	1531.90	D57
58	OPN-SGD58-120LC2	195.8	1531.12	D58
59	OPN-SGD59-120LC2	195.9	1530.33	D59
60	OPN-SGD60-120LC2	196.0	1529.55	D60

#### Absolute Maximum Ratings

Parameter	Symbol	Min	Max	Units	Notes
Storage Temperature	Tstg	-50	85	°C	
Relative Humidity	RH	5	85	%	Non-condensing
Operating Case Temperature	Topr	0	70	°C	OPN-SGD48-120LC2
		-50	85		OPN-SGD48-120LC2I
Power Supply Voltage	Vcc	-0.5	3.6	V	

#### Recommended Operating Conditions

Parameter	Symbol	Min	Typ	Max	Units / Notes
Power Supply Voltage	Vcc	3.13	3.3	3.47	V
Operating Case Temperature	Topr	0		70	°C / OPN-SGD48-120LC2
		-50		85	°C / OPN-SGD48-120LC2I
Relative Humidity	RH	5		85	% / Non-condensing
Power Supply Current	I <sub>CC(TX+RX)</sub>			430	mA / OPN-SGD48-120LC2
				600	mA / OPN-SGD48-120LC2I
Data Rate		100	1250		Mb/s

#### Transmitter Specifications (0°C < Topr < 70°C, 3.13V < Vcc < 3.47V)

Parameter	Symbol	Min	Typ	Max	Units	Notes
<b>Optical</b>						
Average Launch Power	P <sub>o, AVG</sub>	0	---	+5	dBm	1
Center Wavelength Spacing			100		GHz	2
Transmitter Center Wavelength	λ <sub>c</sub>	X-100	X	X+100	pm	3
-- over life time						

### Professional high-speed optical transceiver

Output Spectrum Width	$\Delta\lambda$	---		1	nm	-20 dB width
Side Mode Suppression Ratio	SMSR	30			dB	
Extinction Ratio	$E_R$	9	---	---	dB	
Optical Rise Time	$t_r$			260	ps	20% to 80% Values
Optical Fall Time	$t_f$			260	ps	20% to 80% Values
Relative Intensity Noise	RIN			-120	dB/Hz	
<b>Electrical</b>						
Data Input Current -- Low	$I_{IL}$	-350			$\mu$ A	
Data Input Current -- High	$I_{IH}$			350	$\mu$ A	
Differential Input Voltage	$V_{IH} - V_{IL}$	0.5		2.4	V	Peak-to-Peak
TX Disable Input Voltage -- Low	$T_{DIS, L}$	0		0.5	V	4
TX Disable Input Voltage -- High	$T_{DIS, H}$	2.0		Vcc	V	4
TX Disable Assert Time	$T_{ASSERT}$			10	$\mu$ s	
TX Disable Deassert Time	$T_{DEASSERT}$			1	ms	
TX Fault Output Voltage -- Low	$T_{FaultL}$	0		0.5	V	5
TX Fault Output Voltage -- High	$T_{FaultH}$	2.0		Vcc+0.3	V	5

1. Output power is power coupled into a 9/125  $\mu$ m single-mode fiber.
2. Corresponds to approximately 0.8 nm.
3. X = specified ITU Grid wavelength
4. There is an internal 4.7K to 10K ohm pull-up resistor to VccTX.
5. Open collector compatible, 4.7K to 10K ohm pull-up to Vcc (Host Supply Voltage).

Receiver Specifications (0°C < Topr < 70°C, 3.13V < Vcc < 3.47V)						
Parameter	Symbol	Min	Typ	Max	Units	Notes
<b>Optical</b>						
Sensitivity	Sens			-32	dBm	6
Maximum Input Power	$P_{in}$	-9			dBm	6
Signal Detect -- Asserted	$P_A$	---		-32	dBm	Transition: low to high
Signal Detect -- Deasserted	$P_D$	-45	---	---	dBm	Transition: high to low
Signal Detect – Hysteresis		1.0	---		dB	
Wavelength of Operation		1100	---	1620	nm	
<b>Electrical</b>						
Differential Output Voltage	$V_{OH} - V_{OL}$	0.6		2.0	V	
Output LOS Voltage -- Low	$V_{OL}$	0		0.5	V	7
Output LOS Voltage -- High	$V_{OH}$	2.0		Vcc+0.3	V	7

6. Measured at PRBS 2<sup>7</sup>-1 at BER 1E-12.
7. Open collector compatible, 4.7K to 10K ohm pull-up to Vcc (Host Supply Voltage)

## Professional high-speed optical transceiver

### CONNECTION DIAGRAM

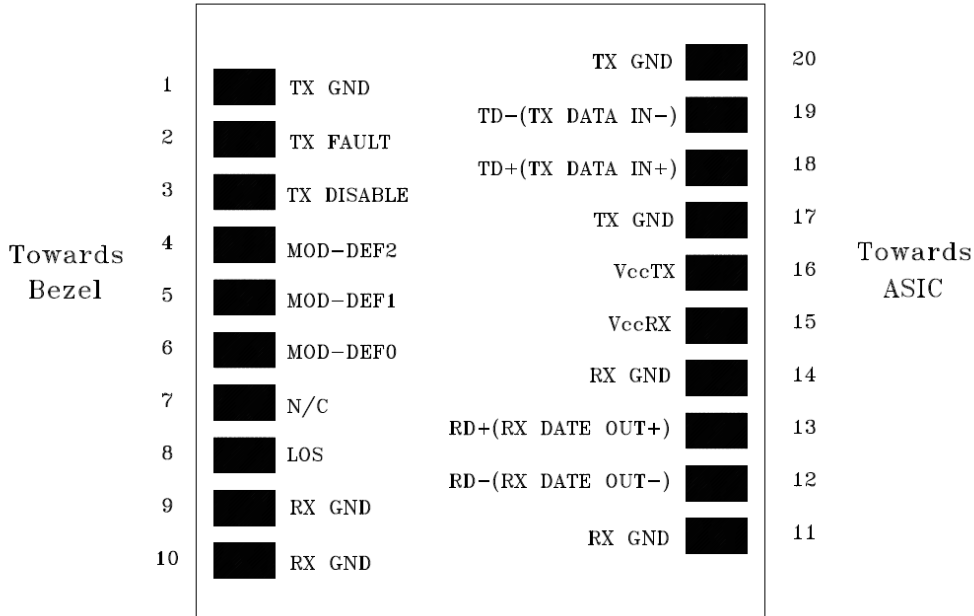

PIN	Signal Name	Description	PIN	Signal Name	Description
1	TX GND	Transmitter Ground	11	RX GND	Receiver Ground
2	TX Fault	Transmitter Fault Indication	12	RX DATA OUT-	Inverse Receiver Data Out
3	TX Disable	Transmitter Disable (Module disables on high or open)	13	RX DATA OUT+	Receiver Data Out
4	MOD-DFE2	Modulation Definition 2 – Two wires serial ID Interface	14	RX GND	Receiver Ground
5	MOD-DEF1	Modulation Definition 1 – Two wires serial ID Interface	15	Vcc RX	Receiver Power – 3.3V±5%
6	MOD-DEF0	Modulation Definition 0 – Ground in Module	16	Vcc TX	Transmitter Power – 3.3V±5%
7	N/C	Not Connected	17	TX GND	Transmitter Ground
8	LOS	Loss of Signal	18	TX DATA IN+	Transmitter Data In
9	RX GND	Receiver Ground	19	TX DATA IN-	Inverse Transmitter Data In
10	RX GND	Receiver Ground	20	TX GND	Transmitter Ground

### MODULE DEFINITION

Module Definition	MOD-DEF2 PIN 4	MOD-DEF1 PIN 5	MOD-DEF0 PIN 6	Interpretation by Host
4	SDA	SCL	LV-TTL Low	Serial module definition protocol

Module Definition 4 specifies a serial definition protocol. For this definition, upon power up, SDA and SCL appear as no connection (NC) and MOD-ABS is TTL LOW. When the host system detects this condition, it activates the serial protocol. The protocol uses the 2-wire serial CMOS E<sup>2</sup>PROM protocol of the ATMEL AT24C01A/02/04 family of components.

## Professional high-speed optical transceiver

### RECOMMENDED CIRCUIT SCHEMATIC



### PACKAGE DIAGRAM

Units in mm

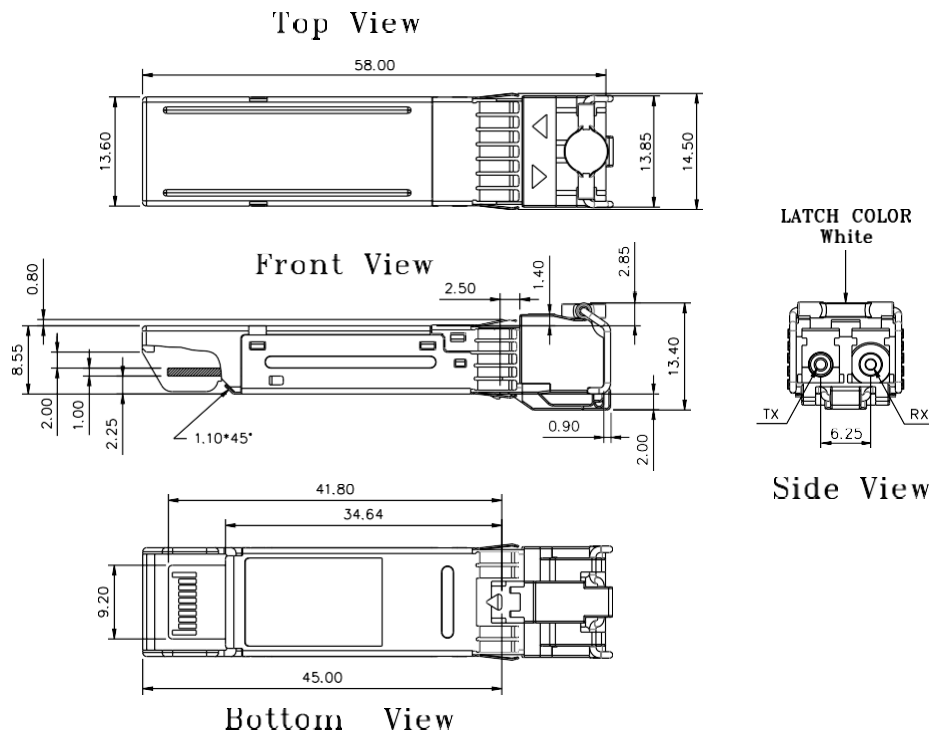

**Note:** Specifications subject to change without notice.