

Professional high-speed optical transceiver

OPN-SG147-D19LC2 / OPN-SG147-D19LC2I

3.3V / CWDM / 1.25 Gbps Digital Diagnostic SFP LC SINGLE-MODE TRANSCEIVER

PRODUCT FEATURES

- Hot-Pluggable SFP Footprint LC Optical Transceiver
- Small Form-Factor Pluggable (SFP) MSA compatible
- Compliant with IEEE 802.3z Gigabit Ethernet1000BASE-XD
 - Compliant with Fibre Channel 1X SM-LC-L FC-PI
 - SFF-8472 Digital Diagnostic Function
- 18 Wavelength (λ): 1270 nm to 1610 nm CWDM DFBLD Transmitter
 - 19 dB Power Budget at Least
 - AC/AC Coupling according to MSA
 - Single +3.3 V Power Supply
 - RoHS Compliant
 - 0 to 70°C Operation: OPN-SG147-D19LC2
 - -50 to 85°C Operation: OPN-SG147-D19LC2I
- Class 1 Laser International Safety Standard IEC-60825Compliant

APPLICATIONS

- Gigabit Ethernet Switches and Routers
- Fibre Channel Switch Infrastructure
 - XDSL Applications
 - Metro Edge Switching

PRODUCT DESCRIPTION

The OPN-SG147-D19LC2I series single mode transceivers are small form factor pluggable module for bi-directional serial optical data communications such as Gigabit Ethernet 1000BASE-XD and Fibre Channel 1x SM-LC-L FC-PI. It is with the SFP 20-pin connector to allow hot plug capability. Digital diagnostic functions are available via an I²C. This module is designed for single mode fiber and operates at a nominal wavelength of CWDM wavelength. There are eighteen center wavelengths available from 1270 nm to 1610 nm, with each step 20 nm. A guaranteed minimum optical link budget of 19 dB is offered. The transmitter section uses a multiple quantum well CWDM DFB laser and is a class 1 laser compliant according to International Safety Standard IEC-60825. The receiver section uses an integrated InGaAs detector preamplifier (IDP) mounted in an optical header and a limiting post-amplifier IC.

ORDER INFORMATION

P/No.	Bit Rate (Gb/s)	1000 BASE	Power Budget (dB)	Wavelength (nm)	Package	Temp. (°C)	TX Power (dBm)	RX Sens. (dBm)	RoHS Compliant
OPN-SG147-D19LC2	1.25	XD	> 19	CWDM*	LC SFP with DMI	0 to 70	0 to -5	-24	Yes
OPN-SG147-D19LC2I	1.25	XD	> 19	CWDM*	LC SFP with DMI	-50 to 85	0 to -5	-24	Yes

CWDM* Wavelength (0 to 70°C)

Central Wavelength	Min. (nm)	Typ. (nm)	Max. (nm)	Clasp Color Code	Central Wavelength	Min. (nm)	Typ. (nm)	Max. (nm)	Clasp Color Code
127	1264.5	1270	1277.5	Light Purple	145	1444.5	1450	1457.5	Yellow Orange
129	1284.5	1290	1297.5	Sky Blue	147	1464.5	1470	1477.5	Gray
131	1304.5	1310	1317.5	Yellow Green	149	1484.5	1490	1497.5	Violet
133	1324.5	1330	1337.5	Yellow Ocher	151	1504.5	1510	1517.5	Blue
135	1344.5	1350	1357.5	Pink	153	1524.5	1530	1537.5	Green
137	1364.5	1370	1377.5	Beige	155	1544.5	1550	1557.5	Yellow
139	1384.5	1390	1397.5	White	157	1564.5	1570	1577.5	Orange
141	1404.5	1410	1417.5	Silver	159	1584.5	1590	1597.5	Red
143	1424.5	1430	1437.5	Black	161	1604.5	1610	1617.5	Brown

CWDM*: 18 Wavelengths from 1270 nm to 1610 nm, each step 20 nm.

Professional high-speed optical transceiver

Absolute Maximum Ratings					
Parameter	Symbol	Min	Max	Units	Notes
Storage Temperature	Tstg	-50	85	°C	
Operating Case Temperature	Topr	0 -50	70 85	°C	OPN-SG147-D19LC2 OPN-SG147-D19LC2I
Power Supply Voltage	Vcc	-0.5	3.6	V	

Recommended Operating Conditions					
Parameter	Symbol	Min	Typ	Max	Units / Notes
Power Supply Voltage	Vcc	3.1	3.3	3.5	V
Operating Case Temperature	Topr	0 -50		70 85	°C / OPN-SG147-D19LC2 °C / OPN-SG147-D19LC2I
Power Supply Current	I _{CC(TX+RX)}		200	300 600	mA / OPN-SG147-D19LC2 mA / OPN-SG147-D19LC2I
Data Rate		100	1250		Mb/s

Transmitter Specifications (0°C < Topr < 70°C, 3.1V < Vcc < 3.5V)						
Parameter	Symbol	Min	Typ	Max	Units	Notes
Optical						
Optical Transmit Power	P _o	-5	---	0	dBm	1
Output Center Wavelength	λ	λ _c -5.5	λ _c	λ _c +7.5	nm	2
Output Spectrum Width	Δλ	---	---	1	nm	-20 dB Width
Side Mode Suppression Ratio	SMSR	30			dB	
Extinction Ratio	E _R	9	---	---	dB	
Optical Rise Time	t _r			260	ps	20 % to 80% Values
Optical Fall Time	t _f			260	ps	20 % to 80% Values
Relative Intensity Noise	RIN			-120	dB/Hz	
Electrical						
Data Input Current – Low	I _{IL}	-350			μA	
Data Input Current – High	I _{IH}			350	μA	
Differential Input Voltage	V _{IH} - V _{IL}	0.5		2.4	V	Peak-to-Peak
TX Disable Input Voltage – Low	T _{DIS, L}	0		0.5	V	3
TX Disable Input Voltage – High	T _{DIS, H}	2.0		Vcc	V	3
TX Disable Assert Time	T _{ASSERT}			10	μs	
TX Disable Deassert Time	T _{DEASSERT}			1	ms	
TX Fault Output Voltage -- Low	T _{FaultL}	0		0.5	V	4
TX Fault Output Voltage -- High	T _{FaultH}	2.0		Vcc+0.3	V	4

1. Output power is power coupled into a 9/125 μm single mode fiber.
2. ITU-T G.694.2 CWDM wavelength from 1270 nm to 1610 nm, each step 20 nm.
3. There is an internal 4.7K to 10K ohm pull-up resistor to VccTX.
4. Open collector compatible, 4.7K to 10K ohm pull-up to Vcc (Host Supply Voltage).

Professional high-speed optical transceiver

Receiver Specifications (0°C < Topr <70°C, 3.1V < Vcc < 3.5V)						
Parameter	Symbol	Min	Typ	Max	Units	Notes
Optical						
Sensitivity	Sens			-24	dBm	4
Maximum Input Power	Pin	-3			dBm	4
Signal Detect -- Asserted	Pa	---		-24	dBm	Transition: low to high
Signal Detect -- Deasserted	Pd	-36	---	---	dBm	Transition: high to low
Signal detect -- Hysteresis		1.0	---		dB	
Wavelength of Operation		1100	---	1620	nm	
Electrical						
Differential Output Voltage	V _{OH} - V _{OL}	0.6		2.0	V	
Output LOS Voltage -- Low	V _{OL}	0		0.5	V	5
Output LOS Voltage -- High	V _{OH}	2.0		Vcc+0.3	V	5

4. Measured at 2⁷-1 PRBS at BER 1E-12.

5. Open collector compatible, 4.7K to 10K ohm pull-up to Vcc (Host Supply Voltage).

CONNECTION DIAGRAM

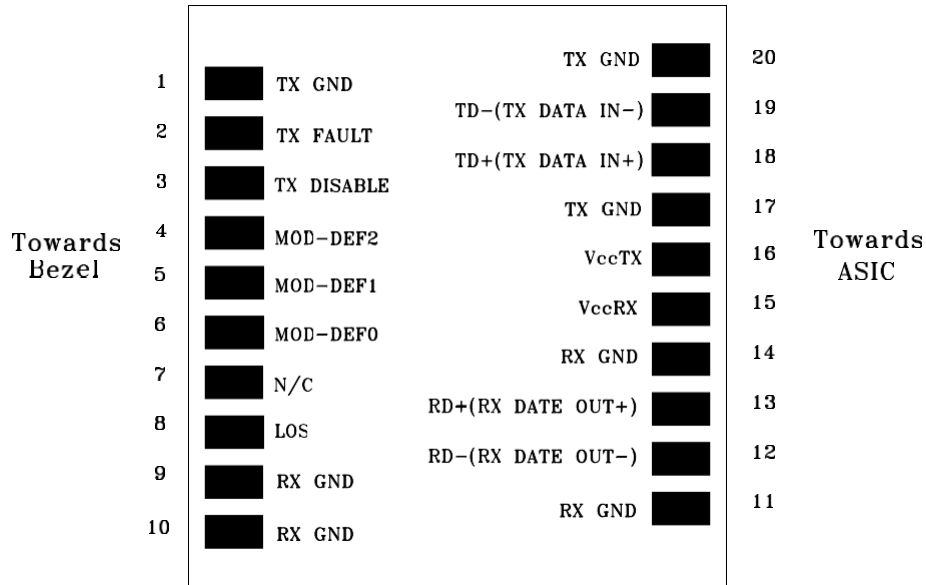

PIN	Signal Name	Description	PIN	Signal Name	Description
1	TX GND	Transmitter Ground	11	RX GND	Receiver Ground
2	TX Fault	Transmitter Fault Indication	12	RX DATA OUT-	Inverse Receiver Data Out
3	TX Disable	Transmitter Disable (Module disables on high or open)	13	RX DATA OUT+	Receiver Data Out
4	MOD-DFE2	Modulation Definition 2 – Two wires serial ID Interface	14	RX GND	Receiver Ground
5	MOD-DEF1	Modulation Definition 1 – Two wires serial ID Interface	15	Vcc RX	Receiver Power – 3.3V±5%
6	MOD-DEF0	Modulation Definition 0 – Ground in Module	16	Vcc TX	Transmitter Power – 3.3V±5%
7	N/C	Not Connected	17	TX GND	Transmitter Ground
8	LOS	Loss of Signal	18	TX DATA IN+	Transmitter Data In
9	RX GND	Receiver Ground	19	TX DATA IN-	Inverse Transmitter Data In
10	RX GND	Receiver Ground	20	TX GND	Transmitter Ground

Professional high-speed optical transceiver

Module Definition

Module Definition	MOD-DEF2 PIN 4	MOD-DEF1 PIN 5	MOD-DEF0 PIN 6	Interpretation by Host
4	SDA	SCL	LV-TTL Low	Serial module definition protocol

Module Definition 4 specifies a serial definition protocol. For this definition, upon power up, MOD-DEF(1:2) appear as no connector (NC) and MOD-DEF(0) is TTL LOW. When the host system detects this condition, it activates the serial protocol. The protocol uses the 2-wire serial CMOS E²PROM protocol of the ATMEL AT24C01A/02/04 family of components.

RECOMMENDED CIRCUIT SCHEMATIC

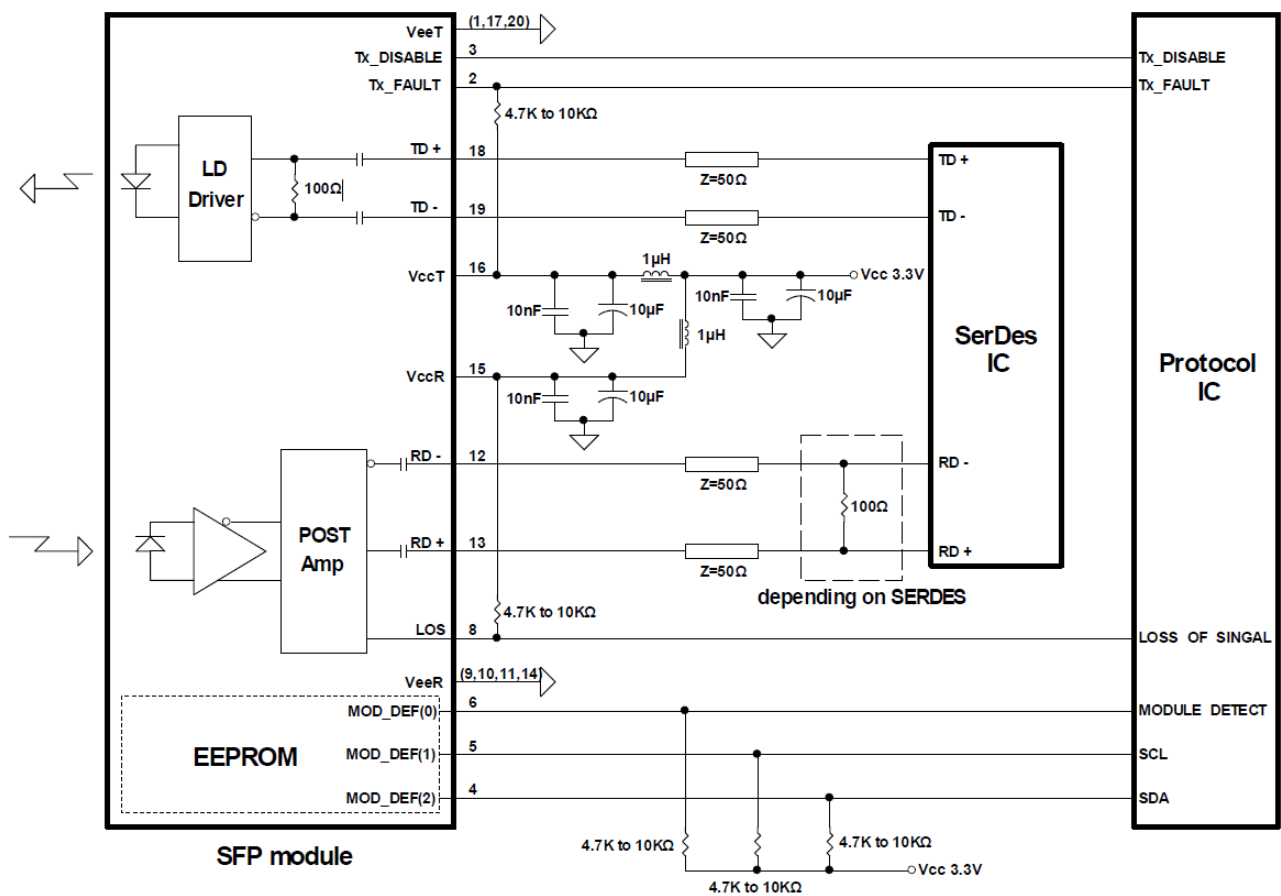

Professional high-speed optical transceiver

PACKAGE DIAGRAM

Units in mm

1)

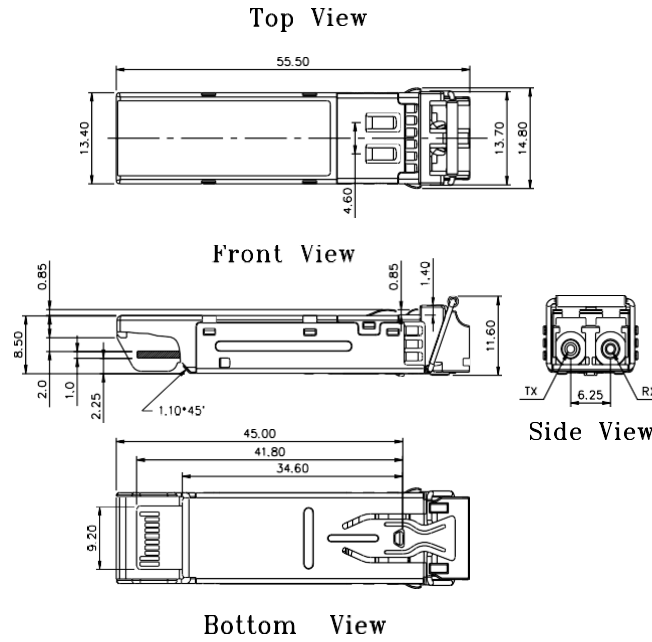

OPN-SG147-D19LC2

2)

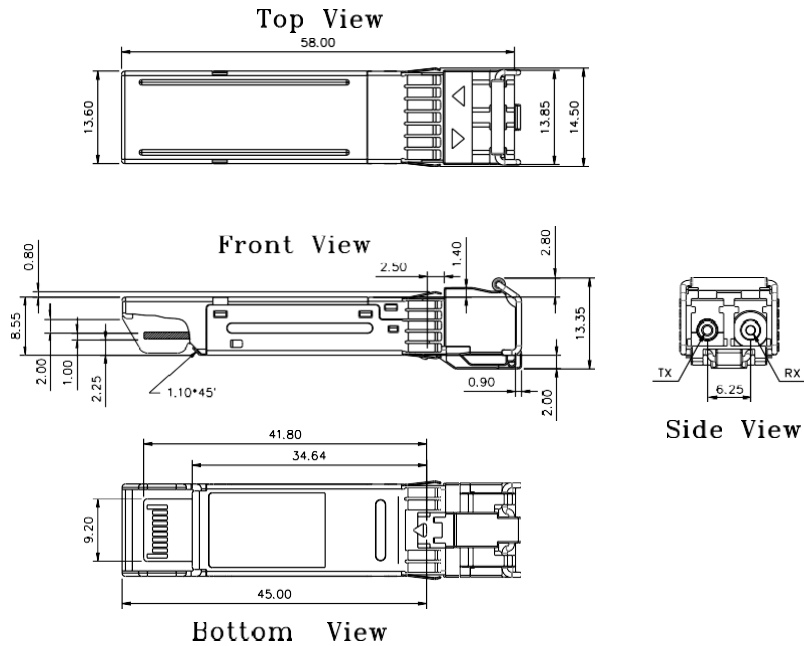

OPN-SG147-D19LC2I

Note: Specifications subject to change without notice.